



STAINLESS STEEL DROP-IN URN TROUGHS

Item #: _____ Qty #: _____

Model #: _____

Project #: _____



FEATURES:

Drop-in Urn Trough requires 5 1/8" wide opening in countertop

1" Flange on all "4" sides supports Trough in countertop

CONSTRUCTION:

All TIG welded

Exposed stainless steel surfaces polished to a satin finish

Slotted Urn Trough Cover Plate

MATERIAL:

16 gauge type "304" Stainless Steel

1 1/2" IPS Drain

DETAILS and SPECIFICATIONS

TOL ± .500"

ALL DIMENSIONS ARE TYPICAL

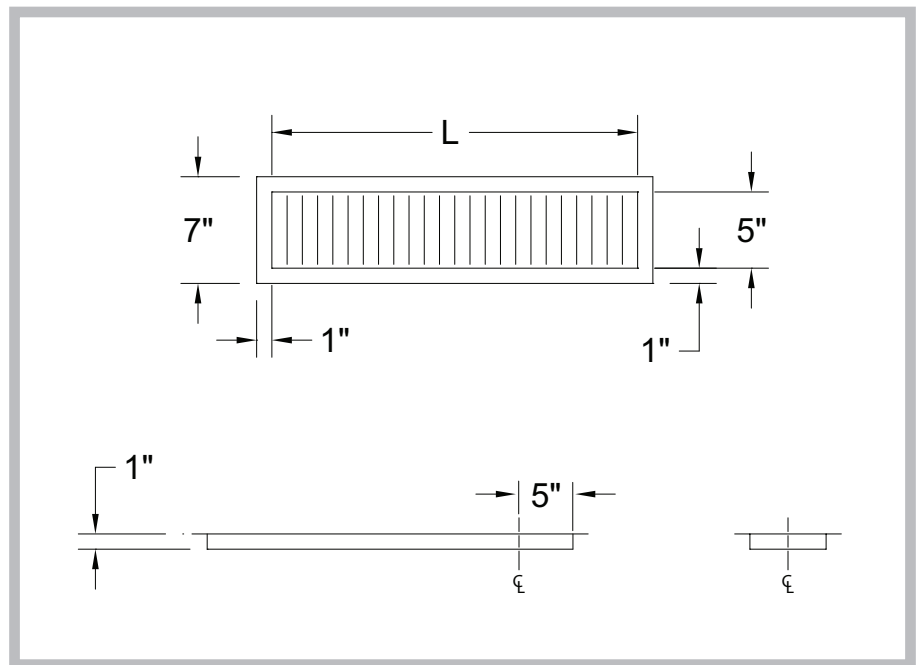

CUSTOM LENGTHS AVAILABLE - CONSULT FACTORY

MODEL #	Length (L)	Cut Out Dimensions
TA-521	12"	5 1/4" x 12 1/4"
TA-522	24"	5 1/4" x 24 1/4"
TA-523	36"	5 1/4" x 36 1/4"
TA-524	48"	5 1/4" x 48 1/4"
TA-525	60"	5 1/4" x 60 1/4"
TA-526	72"	5 1/4" x 72 1/4"
TA-527	84"	5 1/4" x 84 1/4"
TA-528	96"	5 1/4" x 96 1/4"
TA-529	108"	5 1/4" x 108 1/4"



Customer Service Available To Assist You 1-800-645-3166 8:30 am - 7:00 pm E.S.T.

For Orders & Customer Service:

Email: customer@advancetabco.com or Fax: 631-242-6900

For Smart Fabrication™ Quotes:

Email: smartfab@advancetabco.com or Fax: 631-586-2933