



16 GAUGE STAINLESS STEEL

TWO STATION FLOOR MOUNTED SINK WITH TUBULAR LEGS & CROSS BRACING

ELECTRONIC OPERATED



K-175 Electronic Faucets Included On All "EF" Models

Item #: _____ Qty #: _____
 Model #: _____
 Project #: _____



FEATURES:

- 8 1/2" high backsplash.
- 8" sink bowl depth.
- Two stainless steel "Z" brackets.
- One K-6 3 1/2" rear basket drain.
- Tubular stainless steel legs with flanged feet.
- Side & rear adjustable cross-bracing with leg clamps.
- Electronic Operated:** Includes two K-175 Electronic Faucets.

CONSTRUCTION:

- All TIG welded.
- Welded areas blended to match adjacent surfaces and to a satin finish.

MATERIAL:

- All 16 gauge type "304" stainless steel.
- 1 5/8" tubular "304" stainless steel legs & cross-bracing.
- Stainless steel gussets.

MECHANICAL:

- Single faucet hole punch at each station.

Model #	Length	# of Faucets	Wt.	Cu. Ft.
FC-FM-40EF	40"	2	75 lbs.	15

[Click Here For Install Guide](#)



MULTI-STATION ACCESSORIES & REPLACEMENT PARTS

Model	Description	QTY:
K-6	3 1/2" Drain (1 1/2" I.P.S.)	_____
K-06	Splash Mount Faucet Mounting Kit	_____
K-13	Stainless Steel Soap Dispenser (Wall Mount Only)	_____
K-175	Single Hole, Splash Mounted 3-1/2" Electronic Faucet	_____
K-410	Strainer Plate for 3-1/2" Drain	_____
K-508	Special Sizing Charge (Larger Size Cut Down To Smaller Size)	_____
TA-19	Adjustable Stainless Steel Flanged Bullet Foot	_____



K-175



K-13



K-6

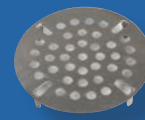

K-410



K-06

= Ships UPS

Standard Faucets conform to NSF 61 Standard 9 and compliance to AB 1953 Standards.

WARNING: Equipment that include faucets on this page may contain a chemical known to the State of California to cause cancer, birth defects or other reproductive harm.



Customer Service Available To Assist You 1-800-645-3166 8:30 am - 8:00 pm E.S.T.

For Orders & Customer Service:

Email: customer@advancetabco.com or Fax: 631-242-6900

For Smart Fabrication™ Quotes:

Email: smartfab@advancetabco.com or Fax: 631-586-2933

DETAILS and SPECIFICATIONS

TOL ± .500"

ALL DIMENSIONS ARE TYPICAL

FC-FM-40EF

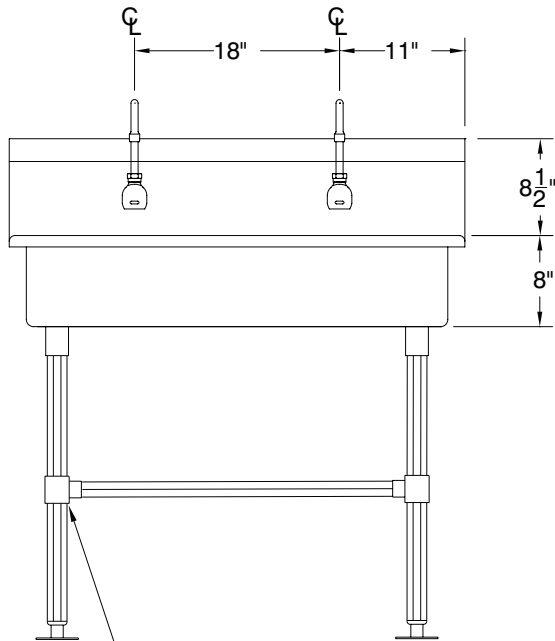
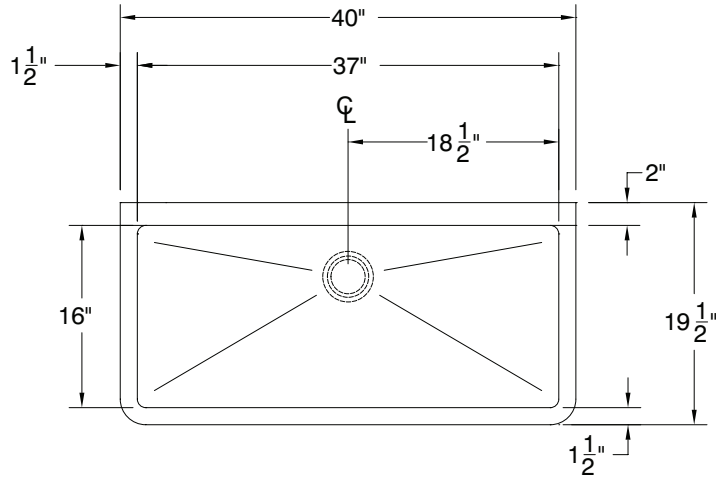

Stainless Steel Rear & Sides
Adjustable Cross-Bracing

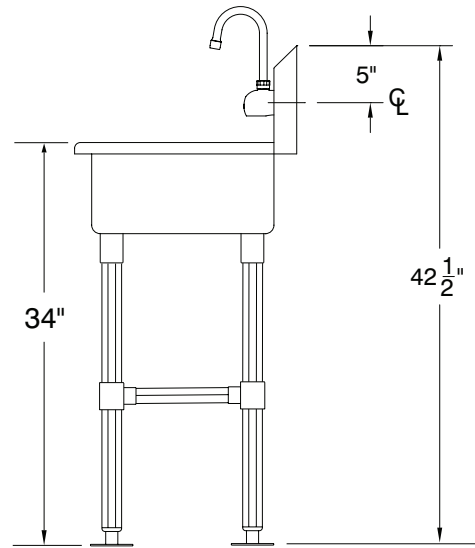

75 Lbs.

